

TC SERIES

TC12-105 (12V105Ah)

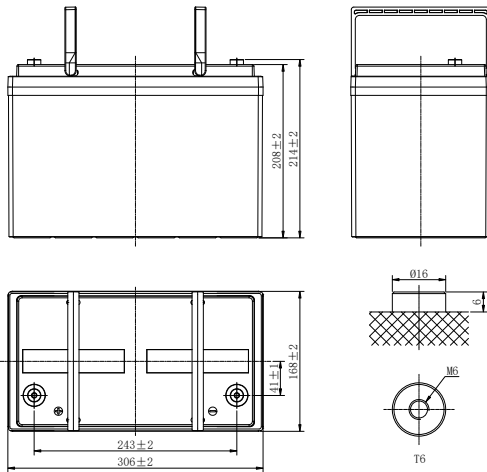

CHARACTERISTICS

Item	Specifications	
Rated Voltage	12V	
Nominal Capacity (25°C)	C ₂₀ , 1.80V/cell	105Ah
Dimension	Length	306mm (12.0inches)
	Width	168mm (6.61inches)
	Container Height	208mm (8.19inches)
	Total Height	214mm (8.43inches)
Approx Weight	29.3kg (64.6lbs)	
Terminal	T6(M6)	
Container Material	ABS	
Short-circuit current	1900A	
Internal Resistance (25°C)	Approx 5.3 mΩ (Fully charged)	
Operating Temp. Range	Discharge	-20~55°C (-4~131°F)
	Charge	0~40°C (32~104°F)
	Storage	-20~50°C (-4~122°F)
Nominal Operating Temp. Range	25±3°C (77±5°F)	
Max.Charging Current (25°C)	0.25C	
Charge voltage (25°C)	Standby Use	Cycle Use
	2.25-2.30V/cell	2.40-2.47V/cell
Temp. Coefficient	-3mV/cell/°C	-5mV/cell/°C
	40°C (104°F)	103%
Effect of temp. to Capacity	25°C (77°F)	100%
	0°C (32°F)	86%
Self Discharge	TC series batteries may be stored up to 6 months at 25°C (77°F) and then a freshening charge is required. For higher temperatures the time interval will be shorter.	

DISCHARGE TABLE

Constant Current Discharge (Amperes) at 25°C (77°F)									
F.V/Time	1h	2h	3h	4h	5h	6h	8h	10h	20h
1.85V/cell	47.5	29.6	22.3	18.1	15.9	13.7	11.0	9.30	5.01
1.80V/cell	52.3	32.4	24.5	19.6	16.7	14.5	11.5	9.50	5.25
1.75V/cell	58.0	34.2	25.3	20.1	17.2	15.0	11.6	9.80	5.34
1.67V/cell	59.9	36.1	26.0	20.5	17.4	15.2	11.8	9.90	5.40
1.60V/cell	61.8	36.7	26.3	20.9	17.6	15.4	11.9	10.0	5.44

Constant Power Discharge (Watts/cell) at 25°C (77°F)									
F.V/Time	1h	2h	3h	4h	5h	6h	8h	10h	20h
1.85V/cell	92.3	57.8	43.8	35.5	31.2	27.0	21.7	18.4	10.0
1.80V/cell	100.9	63.0	47.9	38.4	32.8	28.5	22.6	18.8	10.4
1.75V/cell	111.1	66.1	49.3	39.2	33.6	29.3	22.9	19.3	10.6
1.67V/cell	113.4	69.2	50.1	39.8	33.8	29.7	23.2	19.5	10.7
1.60V/cell	115.9	69.8	50.4	40.3	34.1	30.0	23.4	19.7	10.8

TC SERIES

TC12-105 (12V105Ah)



APPLICATIONS

- Caravan/RV
- Marine

GENERAL FEATURES

- 10~12 years design life (25°C)
- Unique plate design, long cycle life ≥550 Cycles @60%DOD
- Wide operating temperature range: -20~55°C
- Low self discharge ≤3% per month
- Excellent deep discharge resilience performance to extend service life

STANDARDS

- Manufactured in Leoch@IATF 16949, ISO 45001, ISO 9001 and ISO 14001 Approved production facilities

Discharge Characteristics

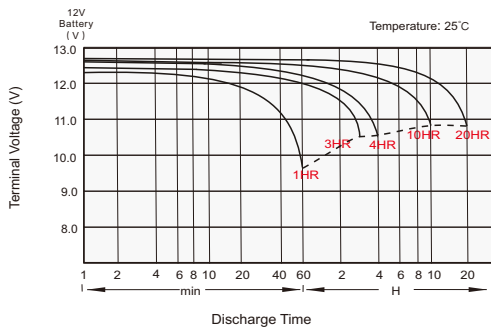

Charging Characteristics

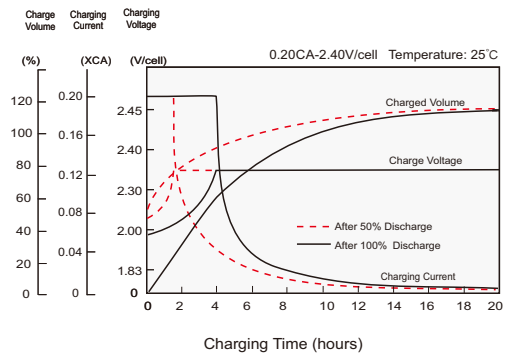

Cycle Life in Relation to Depth of Discharge

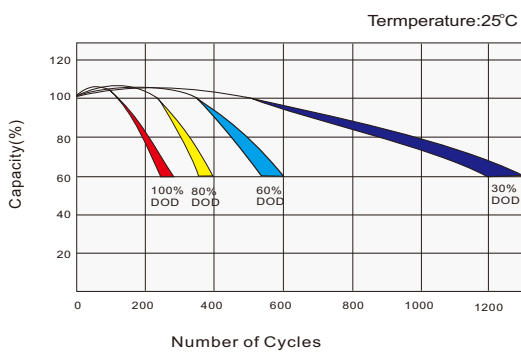

Temperature Effects in Relation to Capacity

